

NOTICE DE MONTAGE

Code: 11225

LOT 31122021

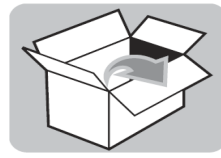

45 MIN

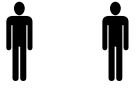

A 1 PC

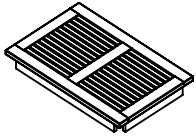

B 4 PCS



C 3 PCS

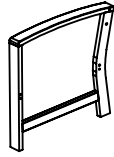

D 3 PCS

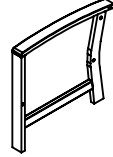

E 1 PC

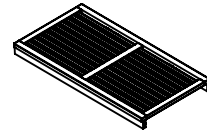

F 1 PC

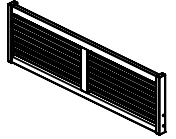

G 2 PCS

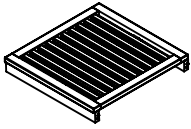

H 2 PCS

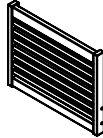

I 1 PC

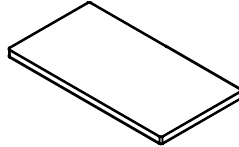

J 2 PCS

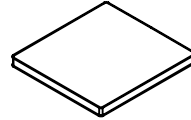

K 4 PCS

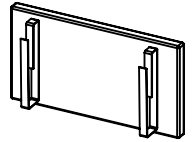

L 8 PCS

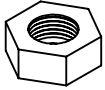

M 8

M 8 PCS



Ø 20xH 1mm

N 6 PCS

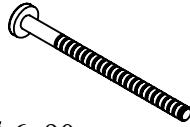

Ø 6x90 mm

O 6 PCS



Ø 6x60 mm

P 12 PCS



Ø 10x6x15 mm

Q 6 PCS



Ø 8x40 mm

R 6 PCS

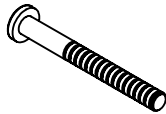

Ø 8x75 mm

S 1 PC

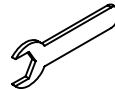

M 13

T 2 PCS

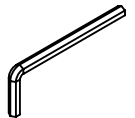

M 4

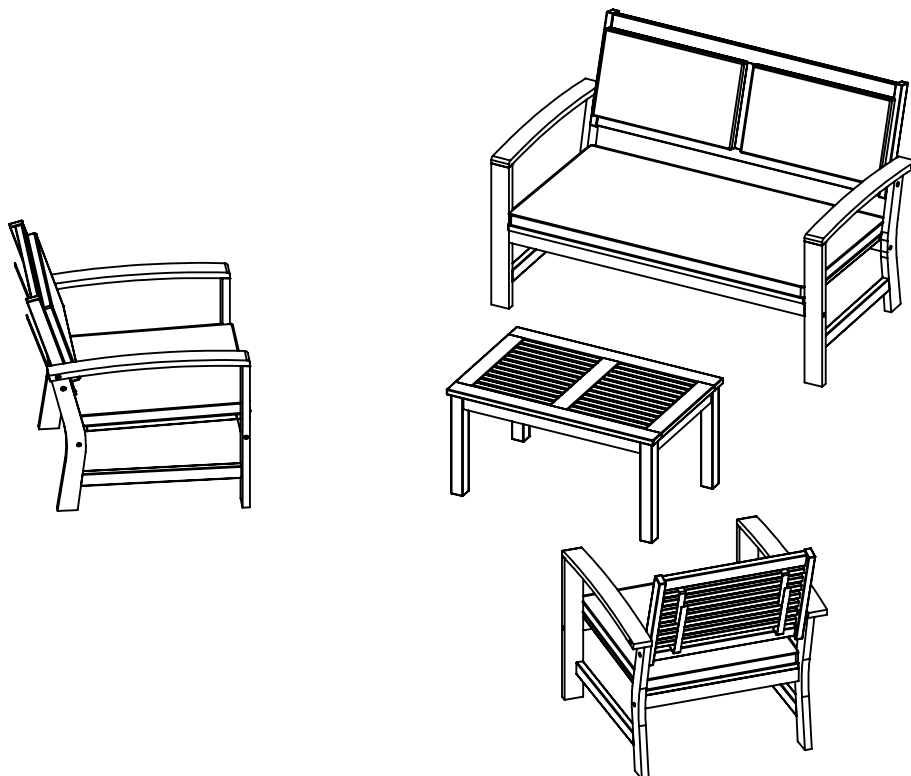

1

TABLE

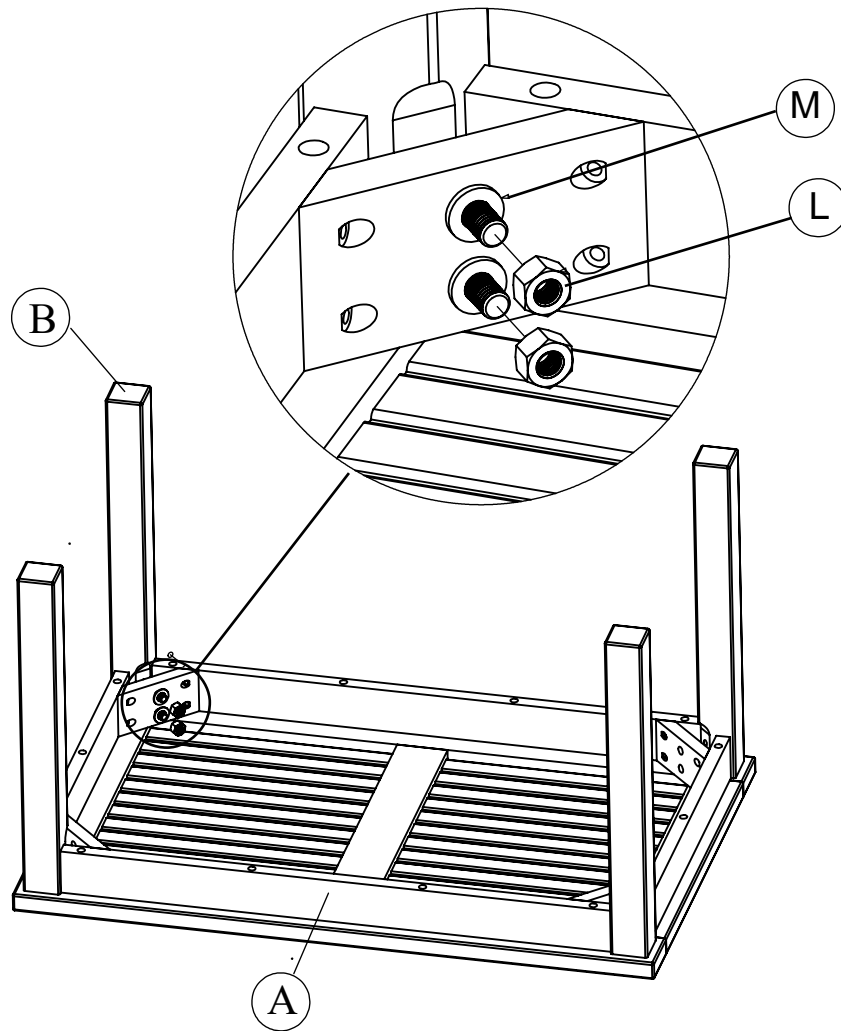

2

CANAPÉ

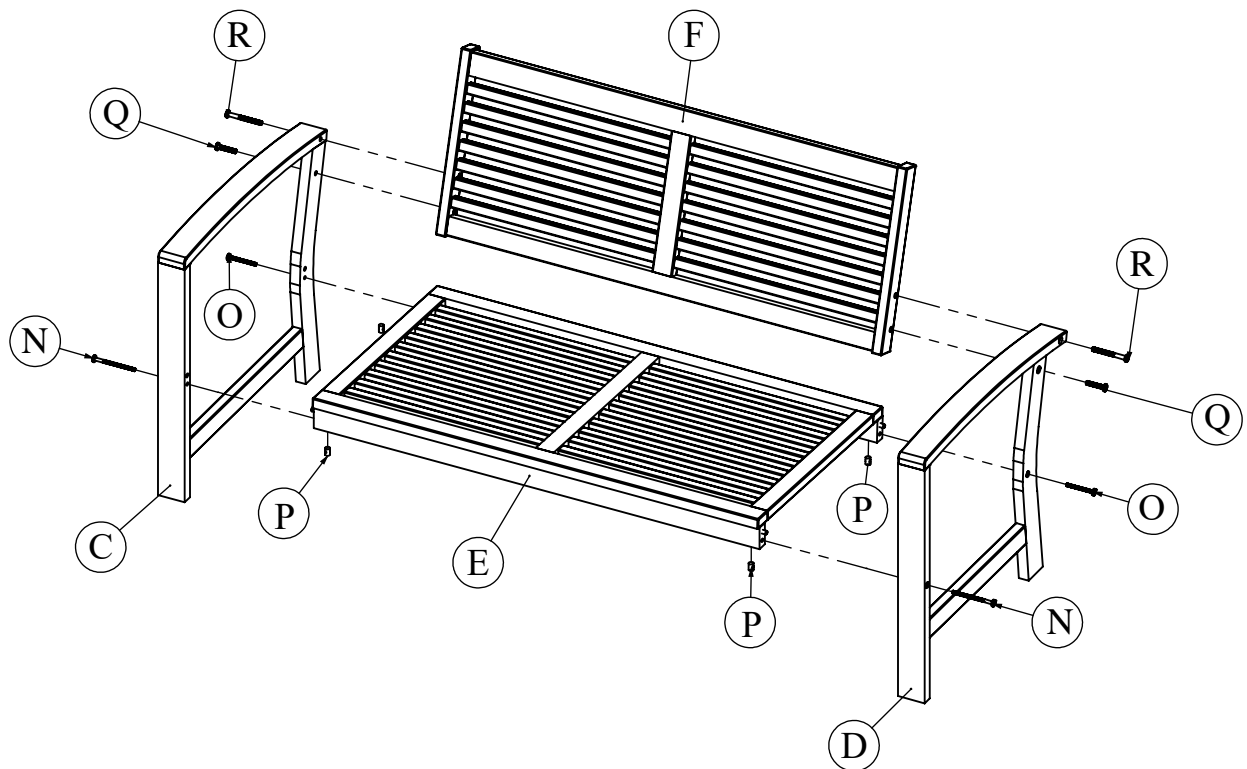

GARANTIE: Tous les produits bénéficiant de la garantie légale de conformité contre les vices cachés prévue par l'article 1641 du code civil durant une période de 2 ans à compter de l'achat du produit. La garantie concerne exclusivement les usages privés.

Exclusion de la garantie:

Usure et vieillissement naturel des matériaux y compris la décoration. Utilisation de produits abrasifs, d'entretien ou de nettoyage inadapté. Chocs ou chutes de toute nature, tout montage ou utilisation inappropriés. Cas de force majeure ou climatiques tels que pluies, vent, orages, grêle...

Tout remplacement ou réparation du produit non conforme ne fait pas courir un nouveau délai de garantie de deux ans mais s'inscrit dans le délai de garantie initiale restant à courir.