

NOTICE DE MONTAGE

Code: 10683

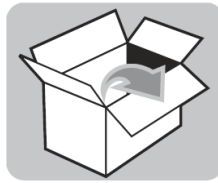

10MIN



1

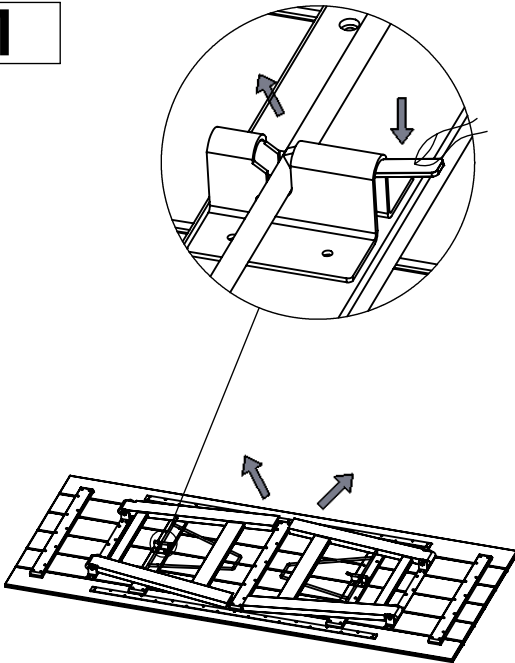

2

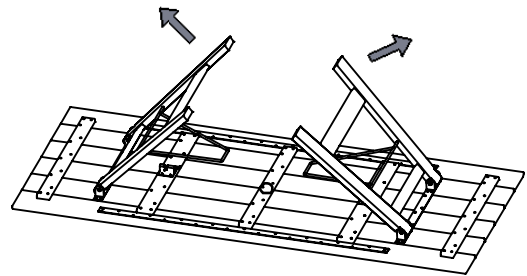

3

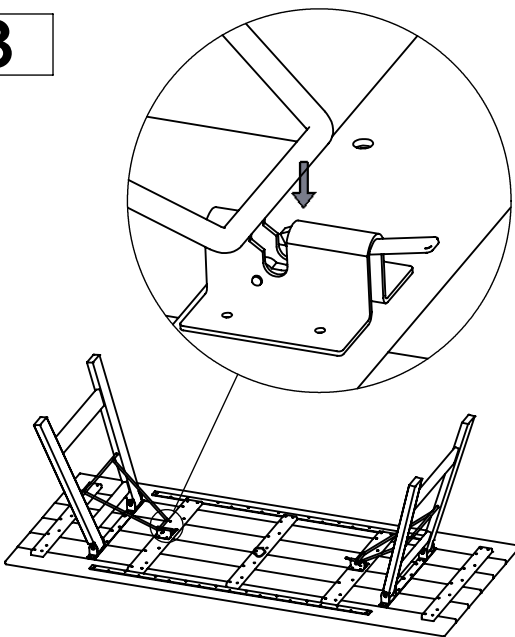

4

